

FFOB-340/4P12D
Stainless Steel lid with 14mm Rebate

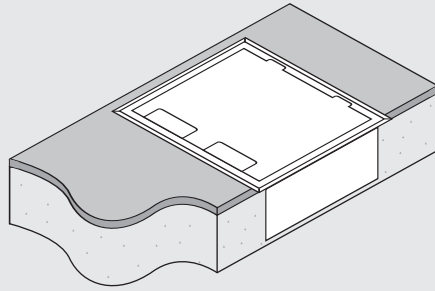

FFOB-340S/4P12D
Solid Stainless Steel lid

AT A GLANCE

- Capacity:** 4 x Clipsal 2000 Series Style Power/ Data/ AV Outlets
- Lid Material:** Stainless Steel
- Lid Size:** 241 x 340mm
- Box Size:** 320 x 220 x 108mm
- Recess Size:** 340 x 240 x 118mm

This Floor Box Weighs Up To: 6.5KG's

Features

Hinged Stainless Steel Lid 241 x 340mm, screw fixes to Steel Box Body

2 x Cord Exit Flaps - allow cords out with main cover closed

Temporary Cover - secure to body during concrete pour to prevent ingress of slurry

Steel Box Body - 320 x 220 x 108mm nom. deep. Has 12 x 25mm conduit knockouts - 2 on each side of box and 4 on the base

Outlet Bracket to Suit 4 x Clipsal 2000 Series Style Power/ Data /AV Outlets

Block-out in concrete slab 340 x 240 x 118mm nom.
Cut-out in raised floor 322 x 222mm nom.

Suitable For CAT6 & CAT6A Cabling

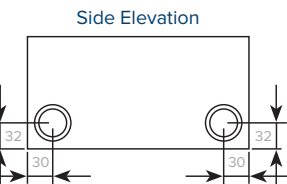
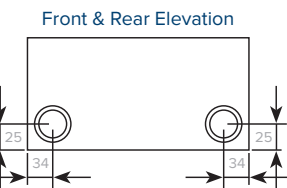
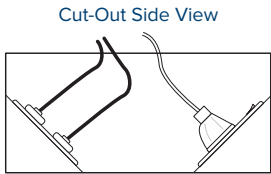
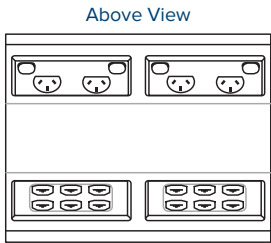

Typical Conduit Hole Location.
Size = Combination 25mm/32mm Conduit Knockouts

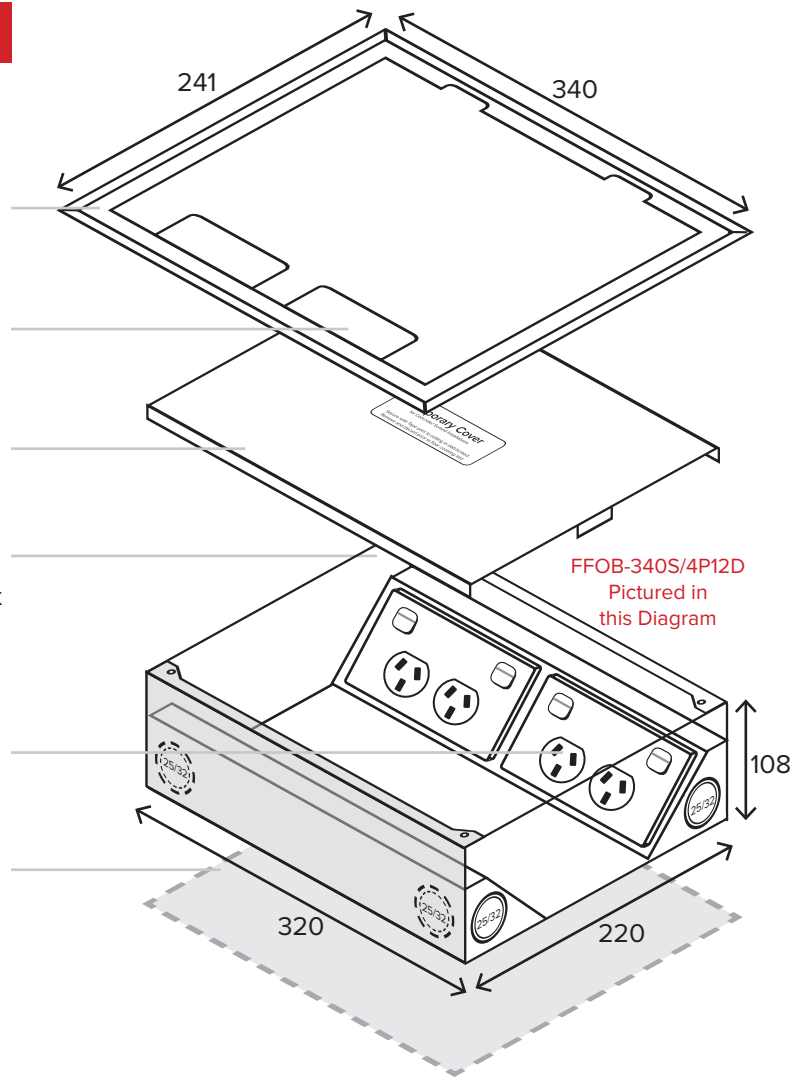

All Dimensions quoted are nominal only. Drawings, images and diagrams are for illustrative purposes only and are not to scale. Product details and dimensions are subject to change without notice. This product is not suitable for use in wet areas, is intended for use with fixed wiring only and must be installed by a licensed electrical mechanic in accordance with AS3000, SAA Wiring Rules and A.C.A Requirements



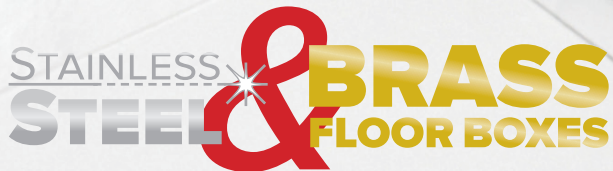

STEP 1: PREPARE AREA FOR INSTALLATION

OPTION 1. SLAB/ SCREED INSTALLATION

- Secure Steel Box Body housing (320x220x108mm) to structural slab (recommended) or within preformed recess/blockout (340x240x118mm). Ensure Box Body is positioned to finish flush and level with final slab surface and is secured to prevent 'dipping' or 'floating' within screed
- Positioning and securing the Box Body accurately will prevent operation/installation problems at later stages
- Connect conduits to Steel Box Body at desired location(s) and cover opening in box body using the Temporary Cover to prevent screed entering the box. Cover screw heads using duct tape, to allow screw removal after screed hardens.

IMPORTANT: SEAL ANY GAPS AROUND CONDUIT ENTRIES WITH SEALANT OR DUCT TAPE PRIOR TO SCREEDING IT

OPTION 2. RAISED/ TIMBER FLOOR, DESK OR COUNTER TOP

- Remove & Discard Temporary Cover. Cut aperture (318x218mm) in floor at desired location. The Floor/ Desk/ Counter is then sandwiched between Lid (above) and Steel Box Body (below).

OR

- Remove & Discard Temporary Cover. The Steel Box Body may be dropped into a 322x222mm aperture and screw fixed through the sides - near the top opening - to prevent it from being lifted out. An adhesive sealant may also provide additional rigidity - apply to the area where the Steel Box Body meets the Floor/ Desk/ Counter. Do not attach Floor Box Lid until any adhesive is hardened so as to avoid contact with lid hinges.
- Optional Floating Floor brackets are available upon request.

STEP 2: FLOOR BOX LID INSTALLATION

- Remove Temporary Cover from Steel Box Body (if not done so already when installing in a raised floor, desk or counter top)
- Lay and trim floor surface (carpet, vinyl, tiles etc) to the size of the *FLOOR BOX STEEL BOX BODY* for *340/4P12D* & *340S/4P12D*
- Terminate outlets as required (as per AS3000) fixing them to the mounting bracket supplied and ensuring all metal components maintain earth continuity
- Fit hinged cover using M4 countersunk screws supplied and test the operation of the unit. Floor coverings under the hinge may interfere with operation - trim any floor coverings clear of the hinging points.

IMPORTANT: THE LID HINGE POINT SHOULD BE ABOVE THE POWER OUTLETS TO ALLOW MAXIMUM ROOM FOR THE CABLES TO EXIT THE FLOORBOX EASILY

